

IRIS S6DR

Infrared Motion Sensor Remote with Dimming

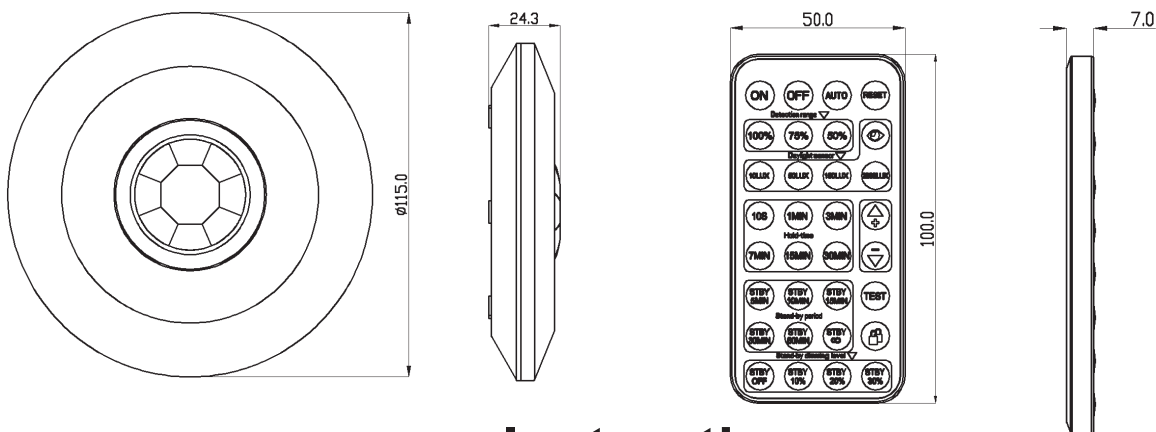

Instruction

Welcome to use SN-PR05E infrared motion sensor!

The product adopts good sensitivity detector and integrated circuit. It gathers automatism, convenience, safety, saving-energy and practical functions. It utilizes the infrared energy from human as control-signal source and it can start the load at once when one enters detection field. It can identify day and night automatically. It is easy to install and used widely.

SPECIFICATION:

Power Source: 220-240V/AC

Power Frequency: 50Hz

Daylight sensor: <3-2000LUX (adjustable)

Hold Time: Min.10sec±3sec

Max.30min±2min

Impulse:1s

Rated Load: Max.2000W 

1000W 

Stand-by Period: 5min, 10min, 15min, 30min

60min, +∞(choice)

Detection Range: 360°

Detection Range: 50%, 75%, 100% (choice)

Detection Distance: 6m max(<24°C)

Working Temperature: -20~+40°C

Power Consumption: approx 0.5W

Installation Height: 2.2-4m

Detection Moving Speed: 0.6-1.5m/s

Automatic Lighting Range: 10LUX-300LUX

Stand-by Dimming Level: OFF, 10%, 20%,

30% (choice)

Note:  short impulse mode means Load will 1sec on, 9sec off

FUNCTION:

- Can identify day and night: The consumer can adjust working state in different ambient light. It can work in the daytime and at night when it is adjusted on the “sun” position (max). It can work in the ambient light less than 3LUX when it is adjusted on the “3” position (min). As for the adjustment pattern, please refer to the testing pattern.
- Hold time is added continually: When it receives the second induction signals within the first induction, it will restart to time from the moment.
- It offers 3 levels of light: 100 %--> dimmed light (10%,20%30%optional) -->off; and 2 periods of selectable waiting time, motion hold time and stand-by period; selectable LUX value and choice of detection area.
- Automatic Lighting: When the ambient light gets brighter, the illumination will get darker. When daylight is insufficient, the lamp will be in 100% illumination level.(eg. The lamp illumination max is 200lux, when the ambient<10lux ,the lamp will on100%, when the ambient>200lux ,the lamp turn off),



Good sensitivity



Poor sensitivity

INSTALLATION ADVICE:

As the detector responds to changes in temperature, avoid the following situations:

- Avoid pointing the detector towards objects with highly reflective surfaces, such as mirrors etc.
- Avoid mounting the detector near heat sources, such as heating vents, air conditioning units, light etc.
- Avoid pointing the detector towards objects that may move in the wind, such as curtains, tall plants etc.



CONNECTION:

- Please move the upper cover with anti-clockwise whirl as per the diagram on the right.
- Connect the power and the load according to the connection-wire diagram.
- Fix the bottom on the selected position with the inflated screw.
- Install back the upper cover on the sensor, then you could switch on the power and test it.

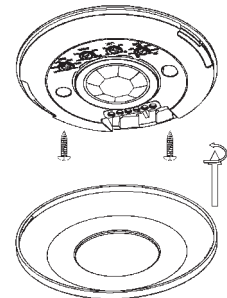

Battery replacement

- Pull out the battery holder
- Put in a new battery (3V)

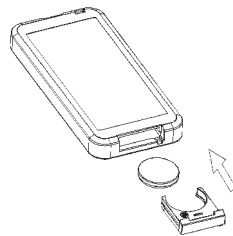

SENSOR INFORMATION:

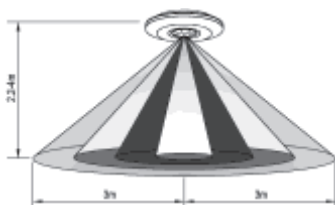

Height of installation:2.2-4m

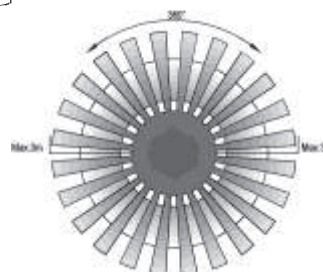

Detection Distance: Max.3m

CONNECTION-WIRE DIAGRAM (See the right figure)

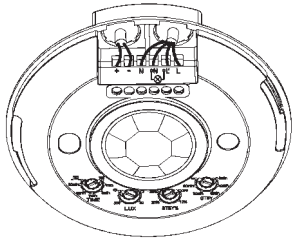

The wires come in and out from the bottom

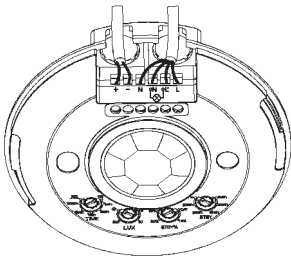

The wires come in and out from the side

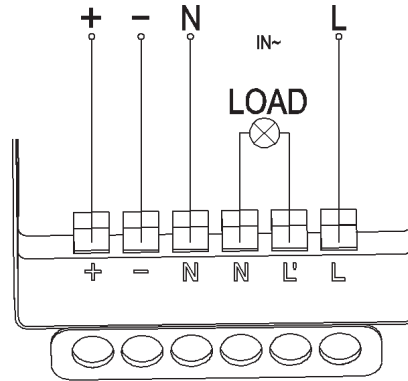

IR REMOTE CONTROLLER

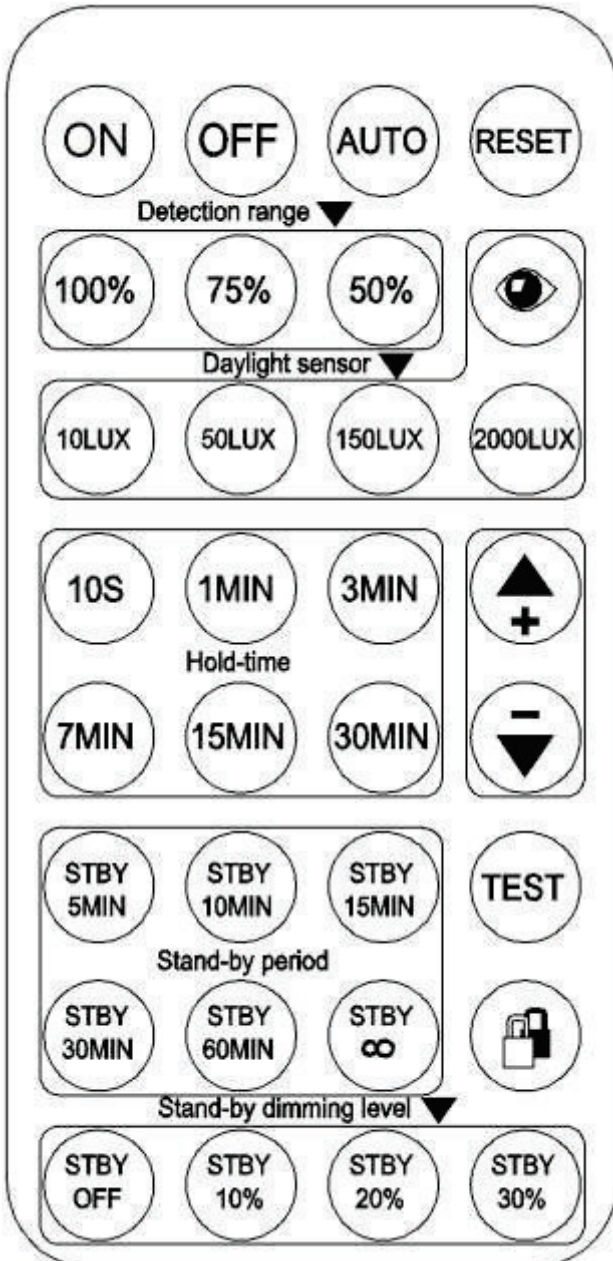

- **ON** Load switching ON
- **OFF** Load switching OFF
- **AUTO** Set load work depending on motion
- **RESET** Sensor works according to knob setting
- **Eye icon** Automatically read-in the actual ambient light level and the sensor works according to this LUX value stored, range 0-2000LUX
- **Lock icon** Lock & unlock remote controller buttons
- **TEST** Test mode
- **100% 75% 50%** Adjust detection range
- **10LUX 50LUX 150LUX 2000LUX** Adjust LUX value from 10-2000LUX
- **10S 1MIN 3MIN 7MIN 15MIN 30MIN** Set delay off time of load
- **STBY 5MIN STBY 10MIN STBY 15MIN STBY 30MIN STBY 60MIN STBY ∞ STBY OFF** Set hold time of load in dimming level
- **STBY 10% STBY 20% STBY 30%** Set load's dimming level or switch off load when there is no motion detection
- **Up/Down arrow icons** Manually adjust illumination level from bright to dark when load is 100% lighting(e.g. from 100% to 10% lighting)

TEST:

- Turn the TIME knob anti-clockwise on the minimum (10s). Turn the LUX knob clockwise on the maximum (sun). Turn the STBY% knob clockwise (10%). Turn the STBY knob anti-clockwise on the minimum (5min).
- When you switch on the power, the light will be on at once, and 10 sec later without induction signal the light will turn off slowly. Then if the sensor receives induction signal, it can work normally
- Adjust the Stand-by Dimming Level to "10%", stand-by period to "5min", when the sensor receives induction signal, the light will be 100% on; 10sec later, the light dims slowly to 10% on for 5min and then turn off. If the sensor receives second induction signal within the stand-by period, the light will be 100% on.

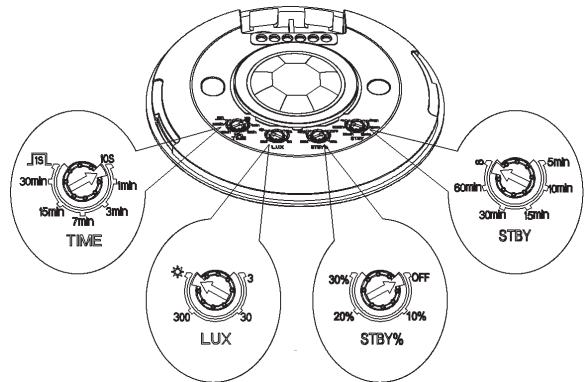

SOME PROBLEM AND SOLVED WAY:

- The load does not work:
 - a. Please check if the connection of power source and load is correct.
 - b. Please check if the load is good.
 - c. Please check if the settings of working light correspond to ambient light.
- The sensitivity is poor:
 - a. Please check if there is any hindrance in front of the detector to affect it to receive the signals.
 - b. Please check if the ambient temperature is too high.
 - c. Please check if the induction signal source is in the detection field.
 - d. Please check if the installation height corresponds to the height required in the instruction.
 - e. Please check if the moving orientation is correct.
- The sensor can not shut off the load automatically:
 - a. Please check if there is continual signal in the detection field.
 - b. Please check if the time delay is set to the maximum position
 - c. Please check if the power corresponds to the instruction.