

TECHNICAL DATA SHEET



NANO 16 (Microwave Motion Sensor)

IP20

2-16m

360°



The product is a new energy saving switch; it adopts microwave sensor with high- frequency electro-magnetic wave (5.8GHz) and integrated circuit. It gathers automatism, convenience, safety, saving-energy and practical functions. The wide\ detection field depends on detectors. When one enters the detection field, it can start the load at once and identify automatically day and night. Its installation is very convenient and its using is very wide. Detection is possible to go through doors, panes of glass or thin walls. This is an ultra-reliable sensor, especially as there are no gaps in the detection zone.

TECHNICAL SPECIFICATION

Power Source:	220-240V/AC
Power Frequency:	50Hz
HF System:	5.8Ghz CW Radar, ISM Band
Transmission Power:	<0.2mW
Time Delay:	Min. 10Sec, Max. 12Min
Rated Load:	800W (Incandescent), 300W (LED Load)
Detection Range:	360°
Detection Distance:	2-16m (radius), Adjustable
Ambient Light:	3-2000LUX
No. of Wires:	4
Install Height:	1.5-3.5m
Power Consumption:	Approx 0.9W
Detection Motion Speed:	0.6-1.5m/s

FUNCTION

- Can identify day and night: It can work in the daytime and at night when it is adjusted on the "sun" position (max). It can work in the ambient light less than 3LUX when it is adjusted on the "3" position (min). As for the adjustment pattern, please refer to the testing pattern.
- SENS adjustable: It can be adjusted according to using location. The detection distance of low sensitivity could be only 2m and high sensitivity could be 16m which fits for large room.
- Time-Delay is added continually: When it receives the second induction signals within the first induction, it will restart to time from the moment.
- Time-Delay is adjustable. It can be set according to the consumer's desire. The minimum time is 10sec±3sec. The maximum is 12min±1min.

INSTALLATION

- 1) All electrical installations must be carried out by suitably qualified and registered electrician.
- 2) Always isolate mains power prior to installation.
- 3) Remove cover by checking the notch on LDR side as shown in Fig 1.
- 4) Use the base to mark the drill holes on the mounting surface.
- 5) Drill holes and insert the wall plugs if required
- 6) Feed power cable and load cable through base holes and securely affix base.
- 7) Connect the power wire and the load wire to the connection terminals according to the electrical connection Fig 2. Do not exceed the max rated load.
- 8) Replace and secure base cover, Calibrate Figure 3. and replace the front cover.

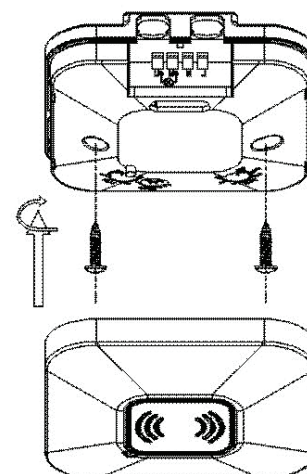

CONNECTION WIRE DIAGRAM APPLICATION

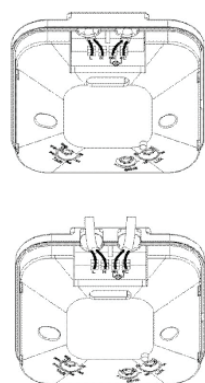

The wires come in and out from the bottom

The wires come in and out from the side

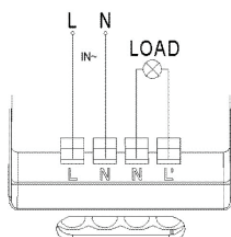

PRODUCT SIZE DIAGRAM

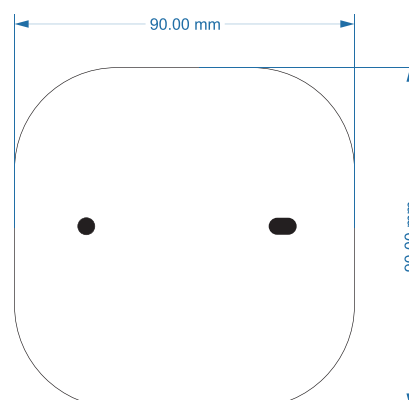

Note: When testing in daylight, please turn LUX knob to (SUN) position, otherwise the sensor could not work!

CALIBRATION

- 1) Sensitivity:** Reach is the term used to describe the diameter of the more or less circular detection zone produced on the ground after mounting the sensor at a height of 2.5 to 6m. Turn the reach control fully anti-clockwise to select minimum reach (approx. 2m dia), and fully clockwise to select maximum reach (approx. 16m dia). Adjust according to locations and site requirements.
- 2) Time Setting:** The light can be set to stay ON for any period of time between approx. 10sec (turn fully anticlockwise) and a maximum of 12min (turn fully clockwise). Any movement detected before this time elapse will re-start the timer. It is recommended to select the shortest time for adjusting the detection zone and for performing the walk test.
- 3) Light Control Setting:** The chosen light response threshold can be adjusted from approx. 2-2000 lux. Turn it fully anti-clockwise to select dusk-to-dawn operation at about 2 lux. Turn it fully clockwise to select continuous daylight operation. The knob must be turned fully clockwise when adjusting the detection zone and performing the walk test in daylight, then adjust setting according to site requirement.

TEST

- Turn the LUX knob clockwise on the maximum (sun). Turn the SENS knob clockwise on maximum (+). Turn the TIME knob anti-clockwise on the minimum (10s).
- When you switch on the power, the light will be on at once. And $10\text{sec} \pm 3\text{sec}$ later the light will be off automatically. Then if the sensor receives induction signal again, it can work normally.
- When the sensor receives the second induction signals within the first induction, it will restart to time from the moment.
- Turn LUX knob anti-clockwise on the minimum (3). If the ambient light is less than 3LUX (darkness), the inductor load could work when it receives induction signal.

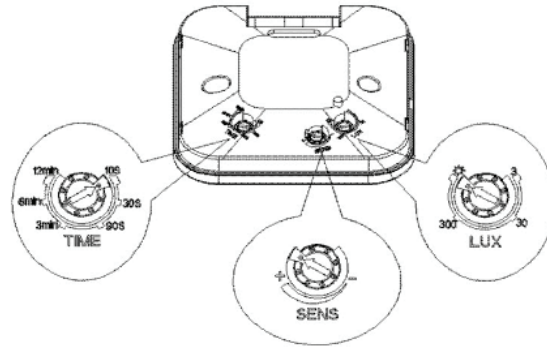

APPLICATION

➤ Daylight Function

The hold time is set to 30 seconds, and the Lux level is set to 300. The light turns on when movement is detected and turns off after people leave, specifically at night. Applications include corridors and staircases.

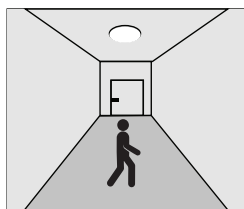

With sufficient daylight (>300 Lux), the light remains off even when motion is detected.

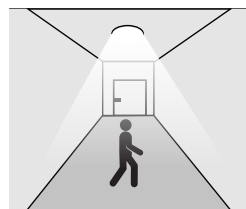

With insufficient daylight (less than 300 Lux), the light turns on when motion is detected.

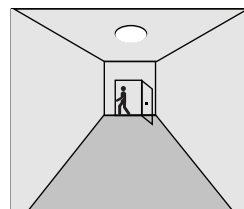

After the last detection and the elapse of the current hold time (30 seconds), the light turns off.

➤ No Daylight Function

The daylight threshold is set to 2000 lux to disable the light. It turns on when movement is detected, and after people leave, the light turns off once the hold time of 30 seconds has elapsed. Applications include dimly lit areas such as basement parking and underpasses.

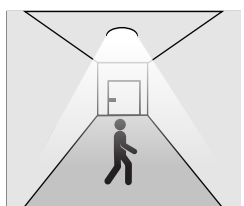

When motion is detected, the sensor will switch the light on to 100% brightness.

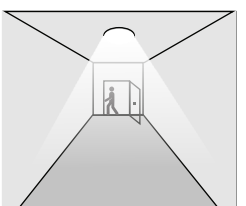

After people leave the detection area, the light remains at 100% brightness for the duration of the hold time.

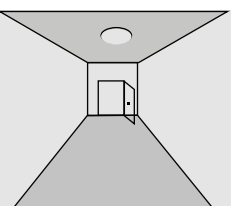

After the last detection and the elapse of the current hold time (30 seconds), the light turns off.

NOTE

- Electrician or experienced human can install it.
- Can not be installed on the uneven and shaky surface
- In front of the sensor there shouldn't be obstructive object affecting detection.
- Avoid installing it near the metal and glass which may affect the sensor.
- For your safety, please don't open the case if you find hitch after installation.

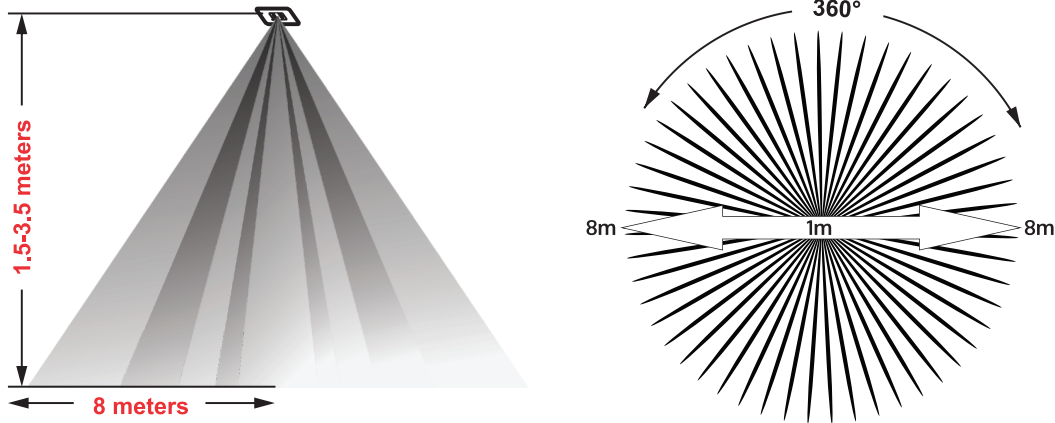

TROUBLESHOOTING

Malfunction	Cause	Remedy
The load will not work	Wrong light control selected Load faulty Mains is switched OFF	Adjust Setting Change Load Switch ON
The load is always on	Continuous movement in detection zone	Check zone setting
The load is ON without any identifiable movement	The sensor not mounted for detecting movement reliably Movement occurred, but not identified by the sensor(movement behind wall, movement of a small object in immediate lamp vicinity etc)	Securely mount enclosure Check zone setting
The load will not work despite movement	Rapid movements are being suppressed to minimize malfunctioning or the detection zone you have set is too small	Check zone setting.